



Sensor de segurança magnético 120VA

O sensor de segurança magnético 120VA possui carcaça cilíndrica M18 em aço inox. Graças à seu design higiênico, que evita o acúmulo de resíduos no sensor e atuador, o sensor de segurança magnético 120VA é muito aplicado na indústria de alimentos e embalagens.

Especificação Técnica

- Classe de proteção IP6K9K, ideal para máquinas que exigem aplicação de jatos d'água
- Tipos de conexões disponíveis: cabo ou conector M12
- Largas distâncias de comutação disponíveis

Desenho técnico

IMAGE 1/3

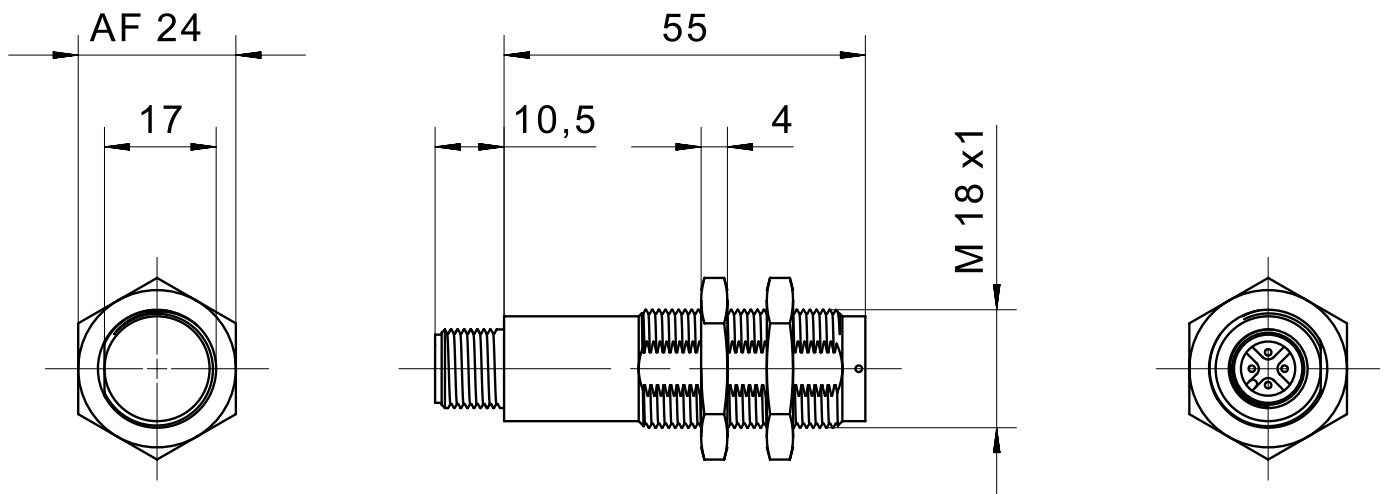
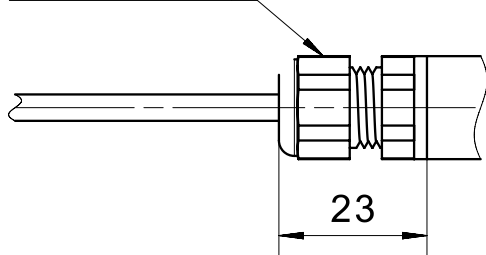
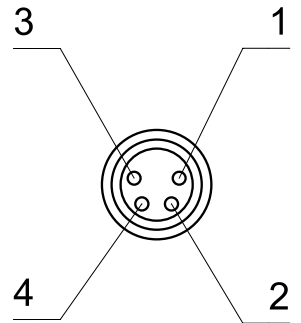

IMAGE 2/3

cable gland
plastic



male M8



cable gland
stainless steel

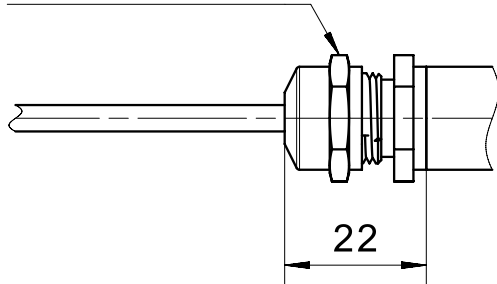

male M12

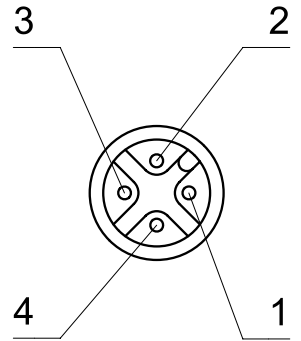

pigtail M8
cable gland
nickel-plated brass

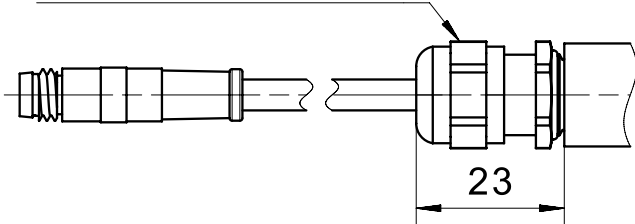
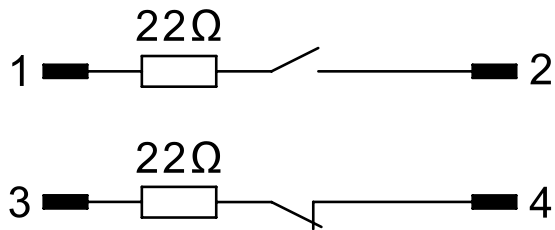
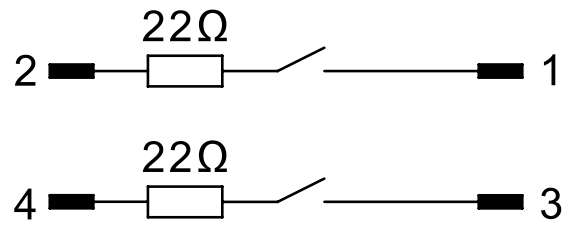

IMAGE 3/3

120272V01, 120272VY01



120V62VY01



120272V, 120272W
120271V, 120272W

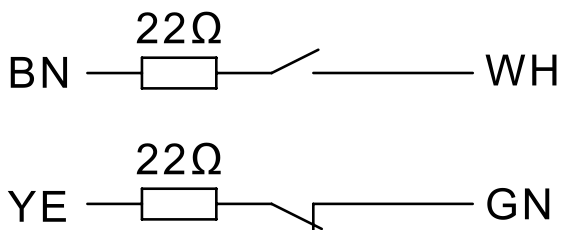

120V62V, 120V62W

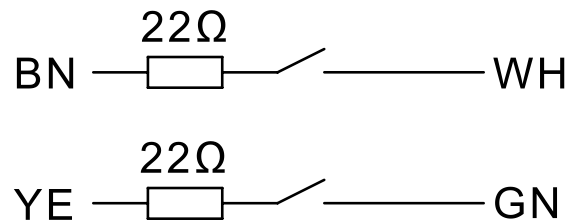

Product options

IMAGE 1/3



Suitable for front actuation. Assured switching distance (Sao) of up to 13 mm with standard actuators, up to 7 mm with extended-range actuators. Assured switch-off distance (Sar) of up to 35 mm with standard actuators, up to 23 mm with extended-range actuators.

IMAGE 2/3

ORDERING KEY

	120V62V	120V62VY01	120V62W	120272V	120272VY01
Stainless steel housing M18	X	X	X	X	X
Plastic cable gland		-	-	X	-
Nickel-plated brass cable gland		-		-	-
Stainless steel cable gland		-	X	-	-
M8x1 pigtail and connector, 4-pin		-	-	-	-
M12x1 housing connector, 4-pin		X	-	-	X
Connection cable 1m*		-	X	X	-
N.O./N.O. contacts		X	X	-	-
N.O./N.C. contacts		-	-	X	X
Coded		X	X	X	X
Uncoded		-	-	-	-

	120272V01	120272W	120271V	120271W	
Stainless steel housing M18	X	X	X	X	
Plastic cable gland	-	-	X	-	
Nickel-plated brass cable gland	X	-	-	-	
Stainless steel cable gland	-	X	-	X	
M8x1 pigtail and connector, 4-pin	X	-	-	-	
M12x1 housing connector, 4-pin	-	-	-	-	
Connection cable 1m*	-	X	X	X	
N.O./N.O. contacts	-	-	-	-	
N.O./N.C. contacts	X	X	X	X	
Coded	X	X	-	-	
Uncoded	-	-	X	X	

* Other cable lengths, cable materials and connector types on request

IMAGE 3/3

MATCHING ACTUATORS

Actuators	Actuation direction	120V62V			120V62VY01			120V62W			120272V			120272VY01		
		S _{0_min}	S _{ao}	S _{ar}	S _{0_min}	S _{ao}	S _{ar}	S _{0_min}	S _{ao}	S _{ar}	S _{0_min}	S _{ao}	S _{ar}	S _{0_min}	S _{ao}	S _{ar}
304 200 00	Front	0.5	4	18	0.5	4	18	0.5	4	18	0.5	4	18	0.5	4	18
304 200 00 V		0.5	4	18	0.5	4	18	0.5	4	18	0.5	4	18	0.5	4	18
304 200 00 H		0.5	4	18	0.5	4	18	0.5	4	18	0.5	4	18	0.5	4	18
304 200 00 S		3	7	20	3	7	20	3	7	20	3	7	20	3	7	20
304 200 00 VS		3	7	20	3	7	20	3	7	20	3	7	20	3	7	20
304 200 00 SH		3	7	20	3	7	20	3	7	20	3	7	20	3	7	20
300 785		-	-	-	-	-	-	-	-	-	-	-	-	-	-	-
300 785 V		-	-	-	-	-	-	-	-	-	-	-	-	-	-	-
300 785 VH		-	-	-	-	-	-	-	-	-	-	-	-	-	-	-

Actuators	Actuation direction	120V62V			120V62VY01			120V62W			120272V					
		S _{0_min}	S _{ao}	S _{ar}	S _{0_min}	S _{ao}	S _{ar}	S _{0_min}	S _{ao}	S _{ar}	S _{0_min}	S _{ao}	S _{ar}			
304 200 00	Front	0.5	4	18	0.5	4	18	-	-	-	-	-	-			
304 200 00 V		0.5	4	18	0.5	4	18	-	-	-	-	-	-			
304 200 00 H		0.5	4	18	0.5	4	18	-	-	-	-	-	-			
304 200 00 S		3	7	20	3	7	20	-	-	-	-	-	-			
304 200 00 VS		3	7	20	3	7	20	-	-	-	-	-	-			
304 200 00 SH		3	7	20	3	7	20	-	-	-	-	-	-			
300 785		-	-	-	-	-	-	0.5	13	35	0.5	13	35			
300 785 V		-	-	-	-	-	-	0.5	13	35	0.5	13	35			
300 785 VH		-	-	-	-	-	-	0.5	13	35	0.5	13	35			

S_{0_min} = minimum switching distance (mm), S_{ao} = operating distance (mm), S_{ar} = assured switch-off distance (mm)

Características do artigo

Attribute	120V62VY01	120272VY01
Min. switching voltage	19.2 V DC	
Max. switching voltage	28.8 V DC	
Max. switching current	0.1 A	
Max. switching power	3 W	
Switching frequency	5 Hz	
Assured switching distance (Sao)	4 mm	
Assured switch-off distance (Sar)	18 mm	22 mm
Minimum switching distance (S0 min)	0.5 mm	
LED display	No	
Actuation	front	
Switching principle	magnetic	
Series resistor	22 Ohm	
Technology	Reed	
Contact form	NO/NO	NO/NC
Pollution degree	3	
Protection class	III	
Coding acc. to EN ISO 14119	Low	
B10d acc. to EN ISO 13849-1	20000000	
Type acc. to EN ISO 14119	4	
Mission time in years	20 a	
Structure acc. to EN ISO 13849-1	Two-channel	
Housing design	cylindrical	
Dimensions	M18 x 55mm	M18 x 55 mm
cannot be mounted flush	yes	
Detent present	no	
Housing material	Edelstahl	
Nut material	Edelstahl	
Housing colour	silber	
Protection class	IP69K DIN 40050-9 - IP68 1bar DIN EN 60529	
Protection class, connector	IP67 DIN EN 60529	
Operating temperature min.	-25 °C	

Attribute	120V62VY01	120272VY01
Max. operating temperature	75 °C	
Shock resistance (Norm)	30g / 11ms	
Vibration resistance (Norm)	10 - 55Hz	
Min. storage temperature	-25 °C	
Max. storage temperature	75 °C	
Mounting type	Fastening nut	
Thread	M18	
Connector type	M12x1 - 4 polig	M8x1 - 4 polig
CE label	yes	
Possible actuators	30420000	